



S2K Identity Systems

---

# Product Guide



# About:

---

**S2K Identity Systems is a leading manufacturer and wholesaler of premium modular aluminium and acrylic signage, wayfinding and display systems.**

Beginning in the early 80's, the Melbourne-based company's Australian-made sign systems have a reputation for quality, longevity and flexibility.

Established for over 35 years, the company's product range has developed and grown over time. The products have maintained their contemporary appeal due to the clean lines, slim profiles and simplicity in design.

The company's manufacturing controls, maintained by long-standing employees with decades of in-house experience, provides reassurance for customers looking for quality and product flexibility.

S2K Identity Systems take pride in its architecturally designed signage and display systems, the high level of quality and its ongoing development of products for both the Australian and International markets.

---

# Contents:

---

**06.** Architectural Modular Series  
(AM Series)

**12.** Bulletin Board Series

**18.** Poster Holder Series

**24.** Paper Hanger Series

**28.** Braille3D

**32.** InfoStrip Series

**36.** fabricate3D

**40.** Archi-Frame Series

**44.** Vertex Series

**48.** Magnetic Sign Series

**52.** Workstation Sign Series

**56.** Whiteboard Sign Series

**62.** Frame-X Series



# The Architectural Modular Series

---

# The Architectural Modular Series:

## S2K Identity Systems AM Series signage system provides a uniquely modular approach to commercial and industrial signage.

This innovative sign system is comprised of three core components: the Base Plate, the Inserts and the Sidelocks.

These may be arranged into a seemingly infinite array of designs with unlimited components, colours, sizes, mounting and graphic options, allowing Architects, Interior Designers and Sign Manufacturers optimal design flexibility.

AM Series components can be arranged into the precisely required configuration, producing signage of outstanding elegance, that is custom designed to suit your fit out, look and feel.



Directory Board with wood grain laminate accent



AM Series Room Sign with digital print 210 x 210

AM SERIES SIGNAGE IS DESIGNED FOR USE IN THE WIDEST OF COMMERCIAL AND INDUSTRIAL APPLICATIONS INCLUDING:

- Personnel
- Departmental
- Directional
- Directory
- Identification
- Wayfinding

### THE AM SERIES ADVANTAGE

- Absolute design flexibility: offers total signage development flexibility.
- Slim and light construction: lightweight and durable aluminium.
- Slimline design (6mm in depth).
- Simple to use: requires no tools or clip devices to change information.
- Easy to maintain: durable aluminium construction requires no maintenance and is easy to clean.
- Cost reduction on updates: single Inserts can be easily updated without replacing the entire sign.
- Security feature: tamper proof locking option available upon request.

This is an overview of the Architectural Modular Series. The images included are just a selection of what can be achieved with the AM Series.

Design your own layout using our standard width and height dimensions listed on the following pg.

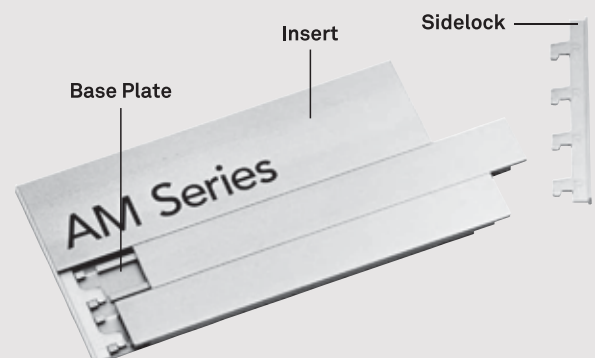



# Architectural Modular Series (AM Series) - Size Chart

Section	a	b	c	d	e	f	g	h	j	k	l	m	n	o	p	q	r	s	t	u	v	w	x	y	z	Increments of 52.5mm to max width of 1890mm
mm	52.5	105	157.5	210	262.5	315	367.5	420	472.5	525	577.5	630	682.5	735	787.5	840	892.5	945	997.5	1050	1102.5	1155	1207.5	1260	1312.5	

Tracks	mm
1	21
2	42
3	63
4	84
5	105
6	126
7	147
8	168
9	189
10	210
11	231
12	252
13	273
14	294
15	315
16	336
17	357
18	378
19	399
20	420
21	441
22	462
23	483
24	504
25	525
26	546
27	567
28	588
29	609
30	630
31	651
32	672
33	693
34	714
35	735
36	756
37	777
38	798
39	819
40	840
41	861
42	882
43	903
44	924
45	945
46	966
47	987
48	1008
49	1029
50	1050
51	1071
52	1092
53	1113
54	1134
55	1155
56	1176
57	1197
58	1218
59	1239
60	1260
61	1281
62	1302
63	1323
64	1344
65	1365
66	1386
67	1407
68	1428
69	1449
70	1470
71	1491
72	1512
73	1533
74	1554
75	1575

HEIGHT OF INSERTS IN MM

## WIDTH OF INSERTS IN MM (excluding sidelocks)

HOW THE AM SERIES WORKS:

**S2K Identity Systems ingenious AM Series is based around only three components:**

- The Base Plate
- The Inserts
- The Sidelocks

## Component 01 - Base Plates

### BASE PLATES

All AM Series signs have a Base Plate. The Base Plate is the backing panel for the sign. It has evenly spaced rails onto which the Inserts slide. The size of the Base Plate is determined by the width and the number of Inserts on the sign. S2K manufacture the Base to suit the requirements of each individual sign.

The Base Plate is always supplied in Satin Natural Anodised finish only.



AM Series directory board with a Poster Holder on the right hand side

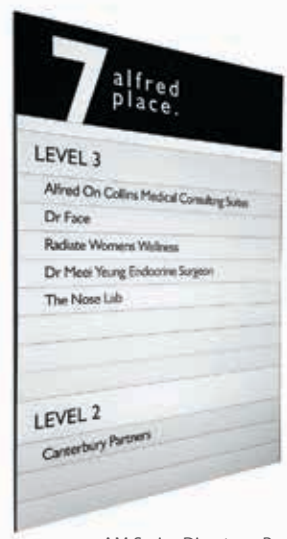

AM Series Directory Board with black anodised header

Increments of 21mm to max height of 1890mm

## Component 02 - Inserts

### INSERTS

Aluminium Inserts are offered in a wide range of sizes. They start at 21mm high and increase in increments of 21mm. For example - 21, 42, 63, 84, 105, and so on. The maximum height for a single Insert is 1197mm High. AM Series Inserts have a flat surface onto which your text and graphics can be applied.

### SLIDER INSERTS

Slider Inserts differ from Inserts in that they have a channel on the face that allows the insertion of an acetate cover or a slider plate. A Slider Insert used with acetate permits the use of paper behind the acetate. Alternatively a Slider Insert accepts a slider plate used to cover or expose a message eg. Vacant/In Use, Open/Closed.

**Slider Inserts are available in 2 sizes, 21mm (1.1) and 42mm (2.1)**

## Component 03 - Sidelocks

The unique AM Series Sidelock system provides a fast and effective means of fastening the Inserts and Base Plates together as a complete sign. Foolproof and simple, the AM Series Sidelock system is available in various widths and end finish profiles. A tamper proof version is also available.

- Standard Sidelocks - 1.5mm are included on all AM Series signs.
- 6mm and 12mm options must be specified.
- 6mm and 12mm options are available with square or radius cut corners.
- Sidelocks are additional to Insert width measurements.

The AM Series offers designers the widest imaginable selection of sign mounting and installation options, graphic and text formats, and of course colours and finishes.

### Inserts

There are 6 standard Insert sizes. They are in increments of 21mm.

For Inserts higher than 126mm, refer to Panel Inserts.

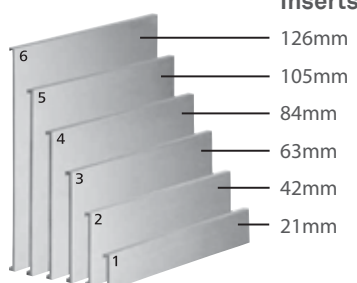

### Panel Inserts

Any Insert that is 147mm or higher. Maximum height for a single Panel Insert is 1197mm.

Sizes are in increments of 21mm High.

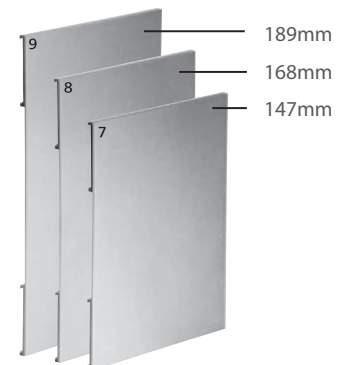

## MOUNTING OPTIONS

- Wall mount
- Door mount
- Frame or stand
- Glass mounted
- Flag mount
- Desk stand
- Suspended
- Flag bracket – single or double-sided
- Workstation bracket – various

## INSTALLATION METHODS

- Double-sided tape
- Silicone & other adhesives
- Concealed screw fixing
- Velcro
- Z-bracket
- Hinged

## SUITABLE USES

- Meetings, conferences; timing or dates
- Staff identification
- Schedules
- Evacuation procedures
- Internal distribution information
- Workstation identification
- Opening hours
- Hospital/Patient identification
- Name plates
- Instructions
- Menus
- Price lists
- Phone extensions / lists
- Staff notices

## GRAPHICS AND TEXT OPTIONS

- Vinyl cut graphics
- Digital prints
- Braille and Tactile graphics
- Silkscreen printing
- Engraving
- 3D lettering

## FINISHES

### Standard Finish

- Satin Natural Anodised Aluminium

### Alternative Finishes for Inserts and Sidelocks

- New York Anodised
- Matte Black Anodised
- Matte Gold Anodised
- Painted – Single Pack or 2 Pack
- Mill Finish – suitable for painting

## CUSTOM COLOURS

The AM Series Inserts and Sidelocks can be painted to your preferred colour. The Base Plate does not require painting.

We recommend single pack or 2 pack spray painting only. Do not powder coat the AM Series, as this finish is too thick for the slimline extrusion profiles.

S2K offers in house painting if required. Please specify your PMS for colour matching.

## COMBINE THE AM SERIES WITH OTHER PRODUCTS IN THE S2K SIGNAGE RANGE

- Bulletin Board Series
- Poster Holder Series
- Paper Hanger Series
- Braille3D
- Whiteboard Sign Series
- Archi-Frame Series

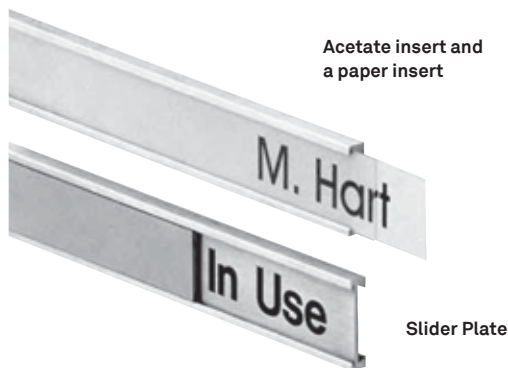

AM Series slider inserts available in 21mm and 42mm



**Satin Natural Anodised**  
Brushed matte finish



**New York Finish**  
Brushed stainless steel look

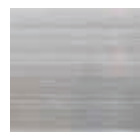

**Mill Finish**  
Raw finish recommended for painting

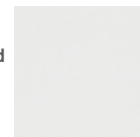

**Painted Finish**  
Single pack or two pack  
Specify your PMS colour



**Matte Gold**  
Brushed matte finish

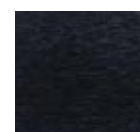

**Matte Black**  
Brushed matte finish

- 01.....AM Series Directory Board
- 02.....210 x 210 Meeting Room Sign with Slider Insert & Slider Plate
- 03.....210 x 210 Flag Mount Sign
- 04.....Directory Board with staff occupancy indicators
- 05.....Desk Sign with paper insert section
- 06.....Directional Sign in both painted and NYF
- 07.....Meeting Room Sign 210 x 63
- 08.....Directory Board 420 x 357 with directional arrows
- 09.....Room Sign 420 x 63 with digital printed graphics
- 10.....AM Series Mini Directory mounted to a desk stand
- 11.....AM Series black anodised directory board mounted to Stainless Steel backing panel

02.



01.

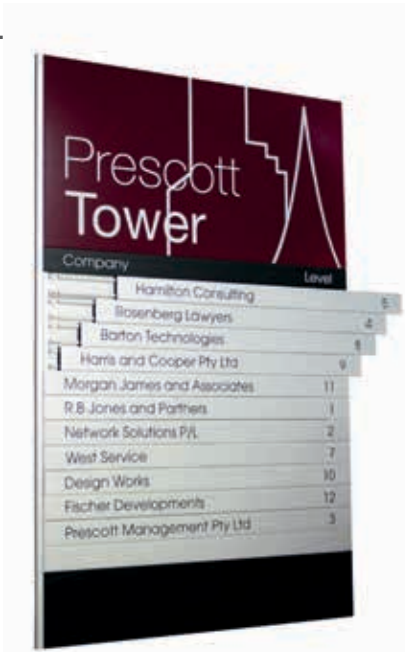

03.



04.



05.



06.



07.



08.



09.



10.



11.

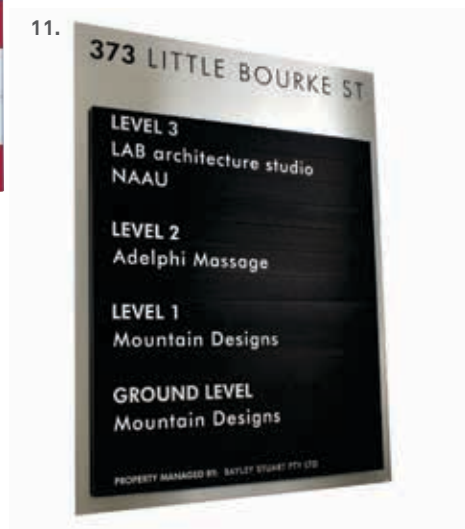



# Bulletin Board Series

---

# Bulletin Board Series:

## The Bulletin Board Series is a modular sign system designed to accommodate printed paper inserts.

They are designed to provide an efficient and effective means of displaying and interchanging graphic information with minimal investment of time or resources.

Computer generated graphics can be produced quickly and easily by the user, enabling signage to be amended or updated whenever required.

The Bulletin Board Series is extremely easy to use, requiring no tools or clip devices to change graphic information.

### HOW THE BULLETIN BOARD WORKS

The Bulletin Board is a frame system designed to accept printed paper inserts.

It consists of an aluminium C Channel frame, a non-glare acrylic cover and flexible grey End Caps.

The unit is side opening allowing the contents to be accessed from either side.

**Note:** The Bulletin Board Series is suitable for interior use only as it is not water proof.

### HOW TO OPERATE

Simply slide the acrylic cover to one side, approximately halfway out of the unit; the flexible End Cap will simultaneously open.

Remove and replace the paper insert by sliding it under the acrylic cover, then slide the acrylic back into its original position.

The End Cap will spring back into place firmly securing the entire unit.

### SIZES

The Bulletin Board Series is available in a variety of standard sizes, please refer to the size charts on pages 15 and 16 for detailed information. Custom sizes are available on request.

### FINISH

- C Channel Frame – Satin Natural Anodised aluminium
- Cover – 3mm clear non-glare acrylic
- End Caps - flexible matte grey plastic

### CUSTOM COLOUR

Painting - The C Channel aluminium section of the unit can be painted to your preferred colour.

All painting must be completed in house by S2K prior to assembly to maintain quality standards. Please specify a PMS code for colour matching.

**Note:** End Caps should only be painted if the unit will not be opened regularly, as paint will wear with frequent use.

### OPTIONAL INSERTS INCLUDE

- Paper - white or coloured
- Light weight cardboard
- Clear acetate
- Photographic material

**Only one piece of paper can be inserted at a time; do not attempt to insert multiple sheets.**

**Note:** Please contact S2K Identity Systems if light weight cardboard or photographic material is to be used. These units require modification during manufacture for these thicker materials.

### COMBINE THE BULLETIN BOARD WITH THE ARCHITECTURAL MODULAR SERIES

Due to the slim profile, the Bulletin Board can be integrated with the Architectural Modular Series. Combining the two systems enables the introduction of Headers, Footers or side panels, thus adding further options to your signage design, functionality and layout.

**Please contact us with details of your preferred design.**



Bulletin Board C4 with an AM Series sign on the left hand side

## ORDERING & SPECIFYING

To order or specify a Bulletin Board please include the following:

1. Quote the code of one of the standard units in this brochure
- OR
2. For a design of your choice please nominate the following:
  - AM Series header (if required)
  - Size and code of chosen Bulletin Board (Refer to sizes on pages 15 and 16)
  - AM Series footer (if required)

For more information please contact S2K directly.

## MOUNTING & INSTALLATION

- Wall mount
- Door mount
- Z Brackets - A4 size only
- Desk stand
- Workstation bracket – various
- Double-sided tape
- Silicone adhesive
- Counter sink screw fixing
- Velcro

These options are subject to the size and the weight of the unit. For more information please contact S2K directly.

## SUITABLE USES

- Meetings, conferences; timing or dates
- Staff identification
- Schedules
- Evacuation procedures
- Internal distribution information
- Workstation identification
- Opening hours
- Hospital/Patient identification
- Name plates
- Instructions
- Menus
- Price lists
- Phone extensions / lists
- Staff notices

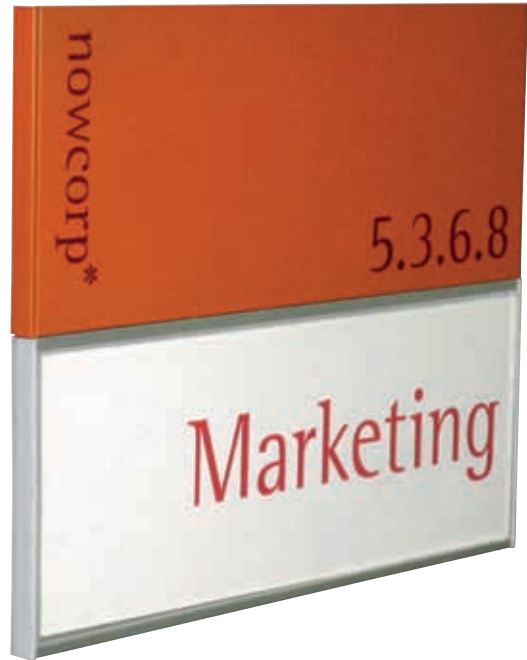

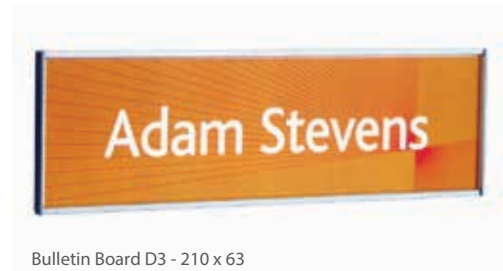

Bulletin Board B3.3 with AM Series Header

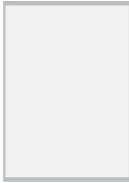
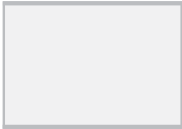

Bulletin Board D3 - 210 x 63

## A4 & A5 BULLETIN BOARDS

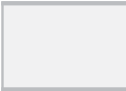
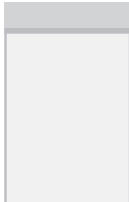
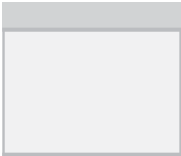
<p><b>BB A4P</b> 210 x 297</p> 	<p><b>BB A4L</b> 297 x 210</p> 	<p><b>BB A5P</b> 148 x 210</p> 	<p><b>BB A5L</b> 210 x 148</p> 
<p><b>BB 2A4P</b> Header 210 x 42 Window 210 x 297</p> 	<p><b>BB 2A4L</b> Header 297 x 42 Window 297 x 210</p> 		



## SIZE GUIDELINES

The diagrams to the right are indicative of the selection of options available.

There are many more options possible, please contact us with your preferred design.

Width Increments are multiples of 52.5mm

Height Increments are multiples of 21mm

Smallest Size available is 105mm Wide X 63mm High.

Largest Size available is A4 – See size diagrams on pages 15 and 16 for more details.

Please add 3mm to the overall width of the listed sizes. This allows for Sidelocks and/or flexible End Caps. Actual paper sizes will be different to sign sizes.

For sizes A4 and larger, please refer to our Poster Holder Series.

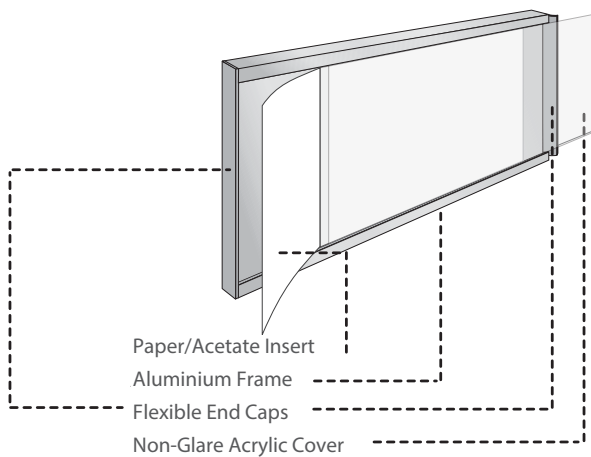

## BULLETIN BOARD SERIES - SIZES

### B 105MM

	B3	B4	B5	B6	B7
<b>Window</b>	105 × 63	105 × 84	105 × 105	105 × 126	105 × 147

### C 157.5MM

	C3	C4	C5	C6
<b>Window</b>	157.5 × 63	157.5 × 84	157.5 × 105	157.5 × 126

### D 210MM

	D3	D3/s	D4	D5	D6
<b>Window</b>	210 × 63	210 × 63	210 × 84	210 × 105	210 × 126

### E 262.5MM

	E3	E3/s	E4	E5	E6
<b>Window</b>	262.5 × 63	262.5 × 63	262.5 × 84	262.5 × 105	262.5 × 126

## BULLETIN BOARDS WITH ARCHITECTURAL MODULAR SERIES HEADERS

### B 105MM

	B1.3	B2.3	B1.4	B2.4	B1.5	B2.5	B2.6
<b>Header Window</b>	105 × 21 105 × 63	105 × 42 105 × 63	105 × 21 105 × 84	105 × 42 105 × 84	105 × 21 105 × 105	105 × 42 105 × 105	105 × 42 105 × 126

### C 157.5MM

	C1.3	C2.3	C2.4	C3.3	C2.5
<b>Header Window</b>	157.5 × 21 157.5 × 63	157.5 × 42 157.5 × 63	157.5 × 42 157.5 × 84	157.5 × 63 157.5 × 63	157.5 × 42 157.5 × 105

### D 210MM

	D2.3	D2.3/s	D2.4	D2.5	D2.6
<b>Header Window</b>	210 × 42 210 × 63	210 × 42 210 × 63	210 × 42 210 × 84	210 × 42 210 × 105	210 × 42 210 × 126

### E 262.5MM

	E2.3	E2.3/s	E2.4	E2.5
<b>Header Window</b>	262.5 × 42 262.5 × 63	262.5 × 42 262.5 × 63	262.5 × 42 262.5 × 84	262.5 × 42 262.5 × 105

## BULLETIN BOARDS WITH ARCHITECTURAL MODULAR SERIES FOOTERS

### B 105MM

	B3.1-F	B3.2-F	B4.1-F	B4.2-F	B5.1-F	B5.2-F	B6.2-F
<b>Window Footer</b>	105 × 63 105 × 21	105 × 63 105 × 42	105 × 84 105 × 21	105 × 84 105 × 42	105 × 105 105 × 21	105 × 105 105 × 42	105 × 126 105 × 42

### C 157.5MM

	C3.1-F	C3.2-F	C4.2-F	C3.3-F	C5.2-F
<b>Window Footer</b>	157.5 × 63 157.5 × 21	157.5 × 63 157.5 × 42	157.5 × 84 157.5 × 42	157.5 × 63 157.5 × 63	157.5 × 105 157.5 × 42

### D 210MM

	D3.2-F	D3.2s-F	D4.2-F	D5.2-F	D6.2-F
<b>Window Footer</b>	210 × 63 210 × 42	210 × 63 210 × 42	210 × 84 210 × 42	210 × 105 210 × 42	210 × 126 210 × 42

### E 262.5MM

	E3.2-F	E3.2s-F	E4.2-F	E5.2-F
<b>Window Footer</b>	262.5 × 63 262.5 × 42	262.5 × 63 262.5 × 42	262.5 × 84 262.5 × 42	262.5 × 105 262.5 × 42



- 01.....Bulletin Board A4L mounted to a desk stand
- 02.....Bulletin-Board D1.8 - 210 x 189
- 03.....Bulletin Board 2A4P with AM Series 42mm Header
- 04.....Bulletin Board D3 210 x 63
- 05.....Bulletin Board C4 157.5 x 84
- 06.....Bulletin Board A4P with Footer 42mm AM Series





# Poster Holder Series

---

# Poster Holder Series:

---

**The Poster Holder Series is a slimline framing system designed for posters and other printed material.**

The Poster Holder is designed to provide an efficient and effective means of displaying and interchanging graphic information or posters with minimal investment of time or resources.

Posters and computer generated graphics can be produced quickly and easily by the user, enabling inserts to be amended or updated in house whenever required.

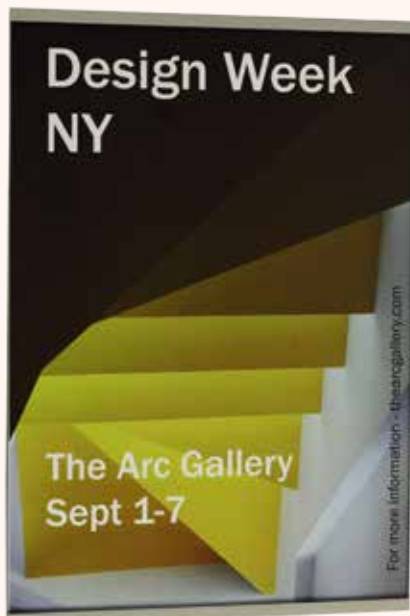

Poster Holder A3 Portrait

## HOW TO OPERATE

The Poster Holder consists of an aluminium backing panel, a grey U channel frame at the top and the bottom, a clear non-glare acrylic cover and grey End Caps.

To change a poster, simply lift the acrylic cover off in an upward motion and remove the existing paper insert. Place the new insert in behind the poster clips then replace the acrylic cover.

As the Poster Holder is top opening, you must allow a 20mm clearance above the installed unit for access.

**A tamper proof option is available on request.**

**NOTE:** The Poster Holder Series is suitable for interior use only as it is not water proof.

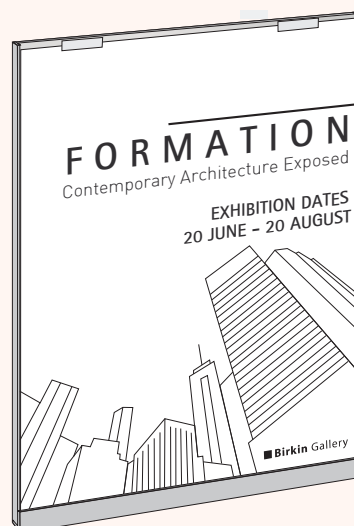

↑  
Lift cover  
upwards  
to open



Poster Holder A2 Portrait

## SIZES

The Poster Holder Series is available to suit the following standard paper sizes:

A4 A3 A2 A1 A0

Both Portrait and Landscape options are available in all sizes; please specify which one you require. See page 23 for layouts.

## CUSTOM SIZES

The Poster Holder is available in any custom size provided it is in between A4 and A0.

A0 is the largest size we manufacture.

For non-standard sizes please specify one of the following:

- The paper size you wish to accommodate
- The outside to outside dimensions of the entire unit
- Custom sizes do not incur penalty charges



Poster Holder A4P mounted to a Desk Stand

## COMBINE THE POSTER HOLDER SERIES WITH THE ARCHITECTURAL MODULAR SERIES

The Poster Holder Series can be used alongside the AM Series. Combining the two systems enables the introduction of headers, footers or a directory board, thus adding another dimension to your signage options.

## OPTIONAL INSERTS

- Paper - white or coloured
- Light weight cardboard
- Clear acetate
- Photographic material

**Only insert one piece of paper at a time. Do not attempt to insert multiple sheets.**

## ORDERING & SPECIFYING

**To order or specify the Poster Holder Series please include one of the following:**

- Quote the code of one of the standard units
- For Custom sizes, include details of paper size or outside to outside dimensions

## FINISH

- Backing panel – Aluminium
- Frame – Grey plastic
- Cover – Non-glare acrylic

## CUSTOM COLOURS

The Poster Holder frame can be painted to your preferred colour. All painting must be completed in house by S2K prior to assembly to maintain quality standards.

Please specify your PMS for colour matching.



Poster Holder A3 Landscape

## MOUNTING & INSTALLATION

- Wall mount
- Door mount
- Z Brackets
- Desk stand - for A4 and A3 sizes recommended
- Workstation bracket – various
- Double-sided tape
- Silicone adhesive
- Counter sink screw fixing
- Velcro

**These options are subject to size and weight, client to specify**

## SUITABLE USES

- Meetings or conferences; timing or dates
- Promotional material
- Schedules
- Evacuation procedures
- Internal distribution information
- Opening hours
- Hospital / Patient Information
- Instructions
- Menus
- Price lists
- Phone extensions
- Staff notices

## FEATURES & BENEFITS

- The Poster Holder is a top opening unit
- Extremely easy to use
- Perfect for frequent graphic changes
- No tools or clips required to change graphics
- There is a security option available in the form of a small grub screw; this will help secure the unit when higher security is required

## SIZE GUIDELINES

The diagrams to the right are a selection of the options available.

Please contact us with your alternative designs.

Please add 3mm to the overall width of the above sizes. This allows for Sidelocks and or the flexible End Caps. Actual sign sizes will differ to paper sizes. For exact dimensions, please contact S2K Identity Systems.

**For sizes smaller than A4, please refer to the Bulletin Board Series.**



01.

02.



03.

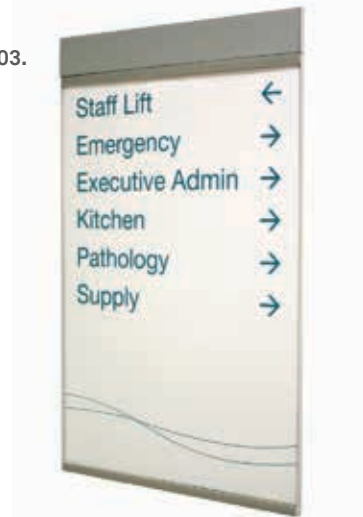

04.

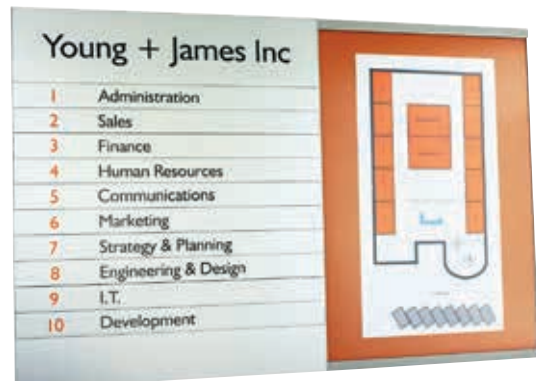

01.....Poster Holder 2A4P with 42mm AM Series Header

02.....Poster Holder A2P

03.....Poster Holder 2A3P with 42mm AM Series header

04.....AM Series directory board with a custom sized Poster Holder on the right hand side

A4 SIZE OPTIONS

	PH A4P	PH A4L	PH 2A4P	PH 2A4L
Header:			210 x 42	297 x 42
Window:	210 x 297	297 x 210	210 x 297	297 x 210

**\*All measurements are paper sizes only.  
Outside dimensions will differ.**

PORTRAIT ORIENTATION - STANDARD SIZES

	PH A4P	PH A3P	PH A2P	PH A1P	PH A0P
Window:	210 x 297	297 x 420	420 x 594	594 x 841	841 x 1189

LANDSCAPE ORIENTATION - STANDARD SIZES

	PH A4L	PH A3L	PH A2L	PH A1L	PH A0L
Window:	297 x 210	420 x 297	594 x 420	841 x 594	1189 x 841

PORTRAIT ORIENTATION WITH HEADERS

	PH 2A4P	PH 2A3P	PH 2A2P	PH 2A1P	PH 2A0P
Header:	210 x 42	297 x 42	420 x 42	594 x 42	841 x 42
Window:	210 x 297	297 x 420	420 x 594	594 x 841	841 x 1189

**Note:** AM Series Footers are also possible.

LANDSCAPE ORIENTATION WITH HEADERS

	PH 2A4L	PH 2A3L	PH 2A2L	PH 2A1L	PH 2A0L
Header:	297 x 42	420 x 42	594 x 42	841 x 42	1189 x 42
Window:	297 x 210	420 x 297	594 x 420	841 x 594	1189 x 841

POSTER HOLDER SERIES WITH FOOTERS - VARIOUS SIZES

	PH 2A4P-F	PH 2A3P-F	PH 2A2P-F	PH 2A4L-F	PH 2A3L-F	PH 2A2L-F
Window:	210 x 297	297 x 420	420 x 594	297 x 210	420 x 297	594 x 420
Footer:	210 x 42	297 x 42	420 x 42	297 x 42	420 x 42	594 x 42





# Paper Hanger Series

---

# Paper Hanger Series:

**Based on the “gravity principle”, the Paper Hanger Series utilises an aluminium extrusion with internal rods that grip and hang paper for display purposes.**

The Paper Hanger Series is ideal for notes, messages, architectural plans, displays, posters or boardroom presentations. It can be attached directly to any clean, flat surface using double-sided foam tape.

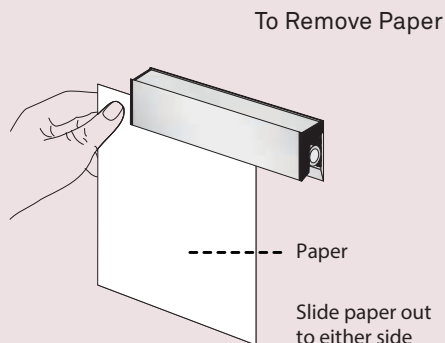
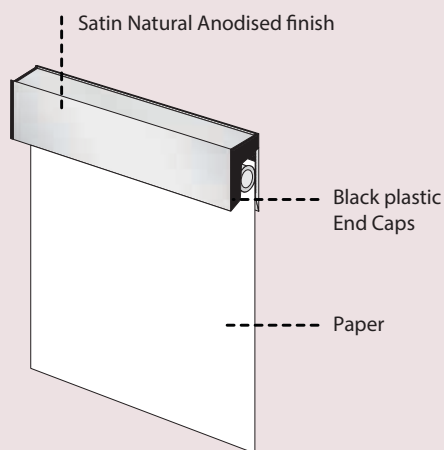

## HOW TO OPERATE

Paper is easily inserted in behind the aluminium rods and is gripped in place through gravity and the grooved surface within the extrusion.

To remove, take the bottom of the paper and lift it up and away from the wall or substrate. Alternatively, slide the paper out sideways to the left or the right.

The Paper Hanger is designed to accept one piece of paper at a time. Do not put more than one piece of paper in the same section. However, individual pieces of paper can sit side by side when longer lengths are used.

## SIZES

The Paper Hanger Series is available in lengths up to 1900mm. It can be cut down to your required size.

Longer lengths can be achieved by removing the black End Caps and butt-joining 2 or more lengths together. End Caps are only required on the extreme left and right of the finished Paper Hanger to secure the rods.

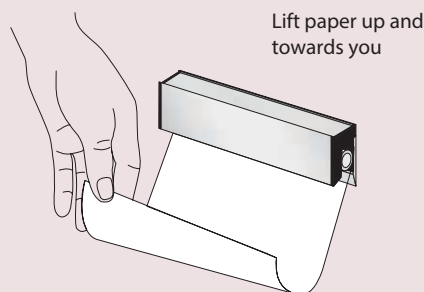

---

## COMBINE THE PAPER HANGER WITH THE ARCHITECTURAL MODULAR SERIES

The Paper Hanger can also be used in combination with the Architectural Modular Series.

The Paper Hanger's 21mm high extrusion allows for it to be attached to the Architectural Modular Series 21mm high Insert with the use of double-sided tape. It can only be added to the bottom Insert of an AM Series sign.

### FINISH

- Aluminium Extrusion - Satin Natural Anodised
- End Caps - black plastic

### MOUNTING & INSTALLATION

- Wall mount
- Door mount
- Workstation bracket – various
- Double-sided foam tape

**Screw fixing is not possible with this product.**

### SUITABLE USES

- Staff notices
- Messages
- Schedules
- Notes
- Opening hours
- Hospital / Patient identification
- Instructions
- Menus
- Price lists
- Phone extension lists



Paper Hanger 420mm Long



Paper Hanger - Detail

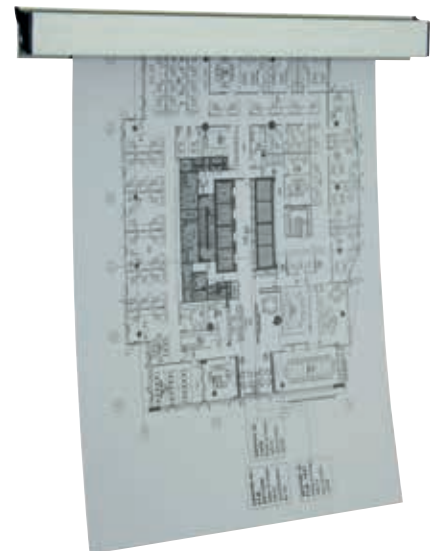

Paper Hanger 300mm Long

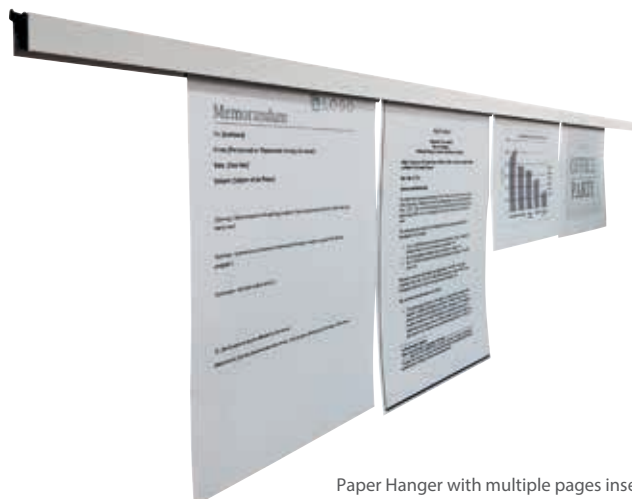

Paper Hanger with multiple pages inserted



Paper Hanger attached to an AM Series Sign

---





# Braille3D:

S2K Identity Systems offer a range of Braille and Tactile signage - Braille3D.

01.



02.



## BRAILLE SIGNS

Braille and Tactile Signage is a requirement of the Australian Building Code section D3.6.

Signage must meet Australian Standards section 1428.

All signage of this type must have both the tactile elements — i.e. symbol or text, as well as Braille. Just one or the other render the signs non-compliant.

Both elements **MUST** be included in all signage to assist both the blind and the visually impaired.

### Braille and Tactile Signs are required for:

- Sanitary facilities
- Accessible areas
- Public Areas
- Room identification
- Area identification
- Exit Levels
- Level Access

## ACCESSIBLE SIGNS

Any sign that includes the Accessible Symbol **MUST** have an Ultramarine Blue background with white symbols and white raised text as per International Standards.

## BRAILLE3D APPLIED TO THE ARCHITECTURAL MODULAR SERIES

Braille3D can be laminated directly to the Architectural Modular Series if interchangeability is required.

## SIZES

We offer a range of standard sizes. Please request our stock list for more information.

Custom sizes and colours are available upon request.

## FINISH

Colours of our standard stock range:

- White on ultramarine blue background
- Black on silver background

Custom colours are also available for either the background or raised symbols and letters.

Please specify 3M Colour or PMS Colour. Suited to quantities only.

All Braille3D standard signs are printed directly to various substrates.

## MOUNTING & INSTALLATION

Braille3D Signs can be installed with double-sided tape.  
Braille signs should be mounted adjacent to a door if possible.

## FEATURES AND BENEFITS

- Compliant with Australian Standards
- Standard stock range offered
- Easy to clean
- Simple to install
- Durable

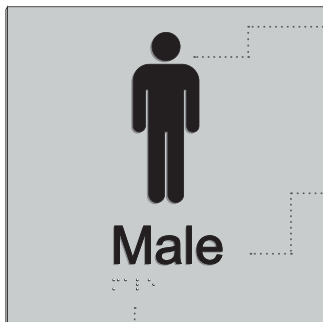

- Symbol must be raised
- Symbol must have rounded edges
- Colour must be a strong contrast to the background colour
- Sign must include text
- Text must be raised
- Text must be centered if a single word, otherwise left justified
- Colour of text must be a strong contrast to the background colour

- Braille must be Grade 1
- Braille must be left justified to text
- Background colour must be a strong contrast to the raised symbol and text

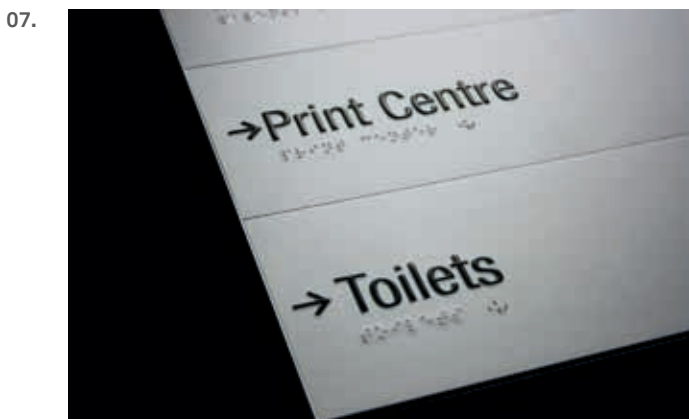

- 01.....AM Series Directory with Braille
- 02.....AM Series Sign with Braille
- 03.....AM Series Sign with Braille
- 04.....Parents Room Sign
- 05.....Accessible Toilet Sign
- 06.....Male Toilet Sign
- 07.....AM Series - Directory with Braille





# InfoStrip Series

---

# InfoStrip Series:

---

**InfoStrip is a ticket strip extrusion that is suitable for labelling shelves, pigeon holes, drawers, cupboards, filing cabinets, display cabinets and much more.**

InfoStrip can be used with a paper insert alone or combined with an acetate cover for added protection and a more professional finish. InfoStrip is suitable for Interior use only. It is not water tight.

01.



02.



03.



## SIZES

- InfoStrip is available at a height of 16mm only
- Maximum length available is 2000mm (2mt)
- InfoStrip can be cut to any length

## OPTIONAL INSERTS

- Paper - white or coloured
- Clear acetate - maximum length of acetate is 1000mm (1mt)
- Perforated paper sheets are available from S2K, the maximum width of sheets is 210mm

## FINISH

- Satin Natural Anodised Aluminium
- Colour option - InfoStrip can be painted if required. A suitable undercoat must be used prior to painting

## MOUNTING & INSTALLATION

- Pigeon hole mount
- Wall mount
- Door mount
- Shelf mount
- Double-sided tape

**InfoStrip can be supplied complete with double-sided tape on request.**

## SUITABLE USES

- Pigeon hole labelling
- Staff identification
- Shelf labels
- Drawer labels
- Workstation identification
- Hospital / patient identification

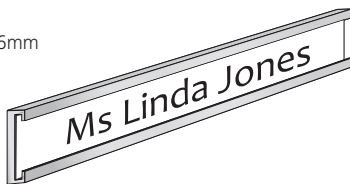
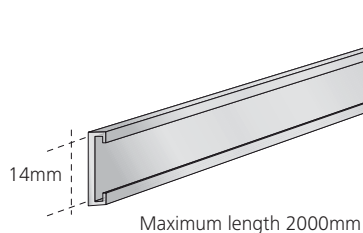

InfoStrip shown with paper inserted.  
An acetate cover can also be inserted over the paper.

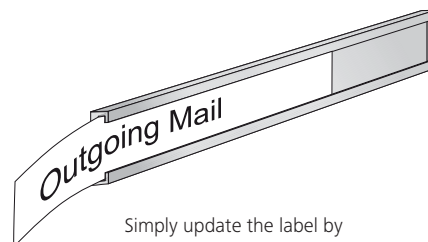

Simply update the label by sliding the paper out and replacing it with a new label.



- 01.....InfoStrip applied to a drawer
- 02.....InfoStrip applied to a cupboard
- 03.....InfoStrip applied to pigeon hole shelving
- 04.....InfoStrip applied to pigeon hole shelving
- 05.....InfoStrip showing detail
- 06.....InfoStrip with both paper and acetate cover



# fabricate3D

---

# fabricate3D:

## fabricate3D is a unique metal fabrication service available from S2K Identity Systems.

We can create intricate precision manufactured 3-Dimensional designs that enable a vast range of possibilities and a new

dimension to corporate identity, branding or signage with very few limitations in design.

This fabrication product is available in a variety of materials and superb finishes.

Many designs that were previously too complex and could not be manufactured with metal are now possible with fabricate3D.

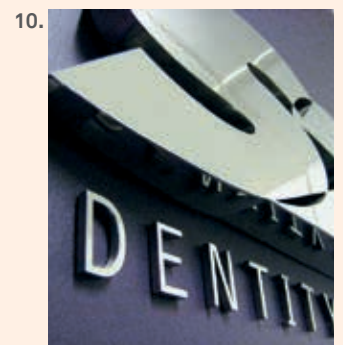
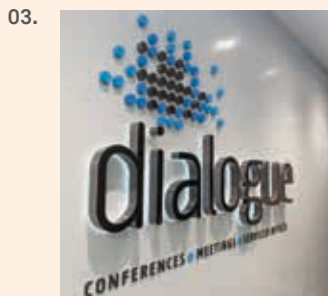

01.....James Squire - Linished Copper

02.....Painted for exterior installation

03.....Black titanium, halo lighting

04.....Polished stainless steel

05.....Hairline stainless steel finish - 9 piece dome logo with painted sides

06.....Oxidised brass shield

07.....Linished copper James Squire Logo

08.....Linished black titanium

09.....Linished and polished stainless steel award

10.....Polished stainless steel S2K logo

## SUITABLE USES

- Reception signs
- Corporate identity
- Company logos
- 3D letters
- Crests
- Directory frames
- Exterior building ID

## MATERIALS & FINISHES

### Available Finishes:

- Stainless Steel - Polished, Linished, Painted
- Brass - Polished, Linished, Oxidised
- Copper - Polished, Linished, Aged
- Titanium - Bronze, Gold, Black, Blue, Polished, Linished

A clear coat is available for all finishes if requested

## SAMPLE FINISHES

More finishes are available; please refer to the Materials & Finishes list above.



POLISHED STAINLESS STEEL



LINISHED STAINLESS STEEL



PAINTED STAINLESS STEEL



POLISHED BRASS



LINISHED BRASS



LINISHED OXIDISED BRASS



POLISHED COPPER



LINISHED COPPER



PATINA COPPER



POLISHED GOLD TITANIUM



LINISHED GOLD TITANIUM



LINISHED BRONZED TITANIUM

## FABRICATION OPTIONS

- Standard – Open backs
- Fully Fabricated – All sides
- Acrylic Backs – Halo lighting
- Acrylic Face – Front lighting

## MOUNTING & INSTALLATION

- Pin fixing
- Screw fixing
- Adhesive

The method of installation will depend on the size and weight of the item.





# Archi-Frame Series

---

# Archi-Frame Series:

**Archi-Frame is a simple framing system that allows the user to showcase their printed graphics whilst also being able to change them as often as needed.**

Archi-Frame is a powder coated aluminium frame with a clear flexible polycarbonate cover.

Archi-Frame is designed to provide a flexible and cost-effective means of displaying and interchanging graphic information with minimal investment of time or resources.

Graphics can be produced quickly and easily by the user, enabling signage to be amended or updated whenever required.

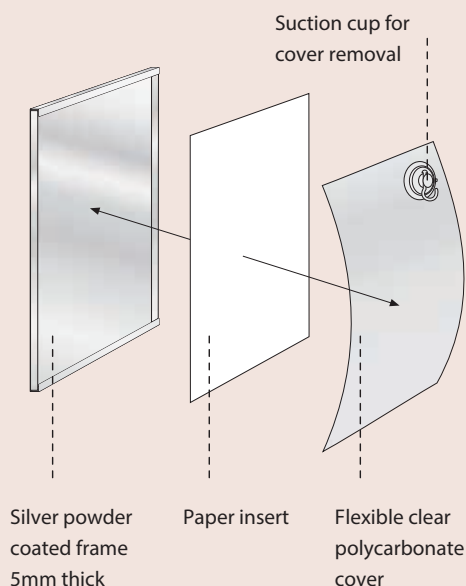

## HOW TO OPERATE

Simply remove the clear flexible cover with the suction cup provided, change or insert the printed paper, then replace the clear cover.

**Archi-Frame is suitable for interior use only. It is not water tight.**

## SIZES

**Archi-Frame is available to suit the following standard paper sizes:**

- A3 portrait & A3 landscape
- A4 portrait & A4 landscape
- A5 portrait & A5 landscape
- A6 portrait & A6 landscape

## COMBINE THE ARCHI-FRAME SERIES WITH THE ARCHITECTURAL MODULAR SERIES

Architectural Modular Series can be combined with the Archi-Frame if it requires the inclusion of a header, footer or a directory board.

Combining the two systems increases the functionality of your chosen signage options.

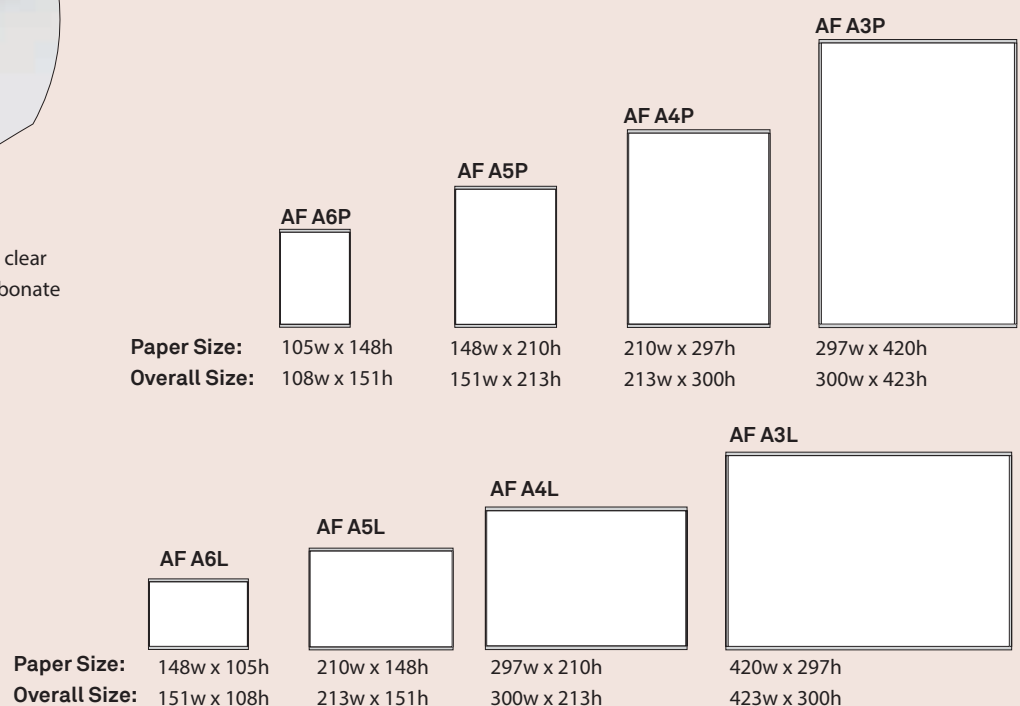

## FINISH

- Frame – aluminium
- Colour – powder coated silver

## MOUNTING & INSTALLATION

- Wall mount
- Door mount
- Z Brackets - A4 size only
- Desk stand
- Workstation bracket – various
- Double-sided foam tape
- Silicone adhesive
- Counter sink screw fixing
- Velcro

## SUITABLE USES

- Staff identification
- Schedules
- Evacuation procedures
- Internal distribution memos
- Workstation identification
- Meetings or conferences; timing or dates
- Opening hours
- Hospital / Patient identification
- Name plates
- Instructions
- Menus
- Price Lists
- Phone extension lists
- Staff notices

## OPTIONAL INSERTS

- Paper - white or coloured
- Clear acetate
- Photographic material
- Any flexible material - maximum thickness 2mm (if used without the clear cover)
- Designed to accept a single piece of paper



- 01.....Archi-Frame A4L with a 42mm AM Series Header
- 02.....Archi-Frame A4P
- 03.....Archi-Frame A4P
- 04.....Archi-Frame A5P
- 05.....Archi-Frame A3P shown open
- 06.....Archi-Frame A3P
- 07.....Archi-Frame A5L





# Vertex Series:

**Vertex Series is an interchangeable panel system. The channel frame is designed to accommodate Panel Inserts in a variety of materials making it easily updatable, accessible and cost effective.**

This system is suitable for wall mounted, ceiling suspended and projecting mounted signs. It is designed to be lighter and easier to update than other systems of its kind.

The Vertex Series channel frame can accept a variety of standard sheet materials thus offering you more choice with your design and graphic options.

The flexible End Caps make it simple to slide the sheet material in and out of the frame.

## HOW TO OPERATE

To interchange the Panel Inserts, simply slide the panel out to one side and the End Cap will flex open enabling removal. Repeat in reverse to replace the new Panel Insert. The End Cap will automatically close once the panel is in place.

### Single Channel

Add a Panel Insert of your choice into the Channel

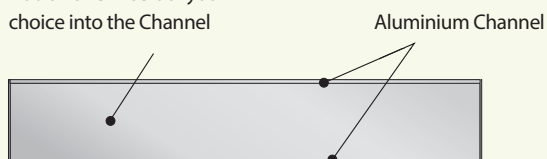

Insert Panel of your choice

- Acrylic
- Aluminium
- Stainless Steel
- Alucobond

### Multiple Channels

Slide panel Insert in or out to change

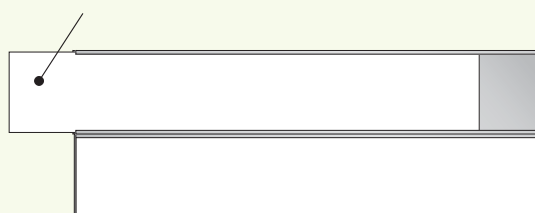

For multiple Panel Inserts, simply add as many Channels as required

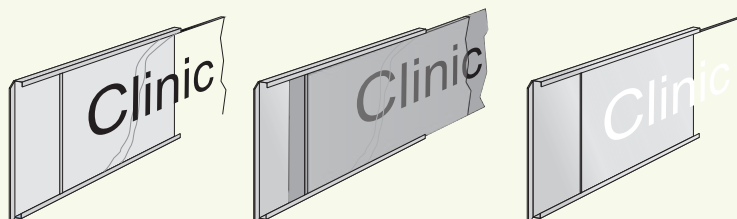

## SIZES

Vertex Series is available in the following sizes:

### Channel Height Options:

- 80mm, 100mm, 120mm, 150mm, 180mm

### Channel Width Options:

- 450mm, 550mm, 650mm, 750mm, 900mm,
- 1100mm, 1300mm, 1500mm.

**Multiple Inserts** - just add as many channel sections as you require.

## OPTIONAL INSERT PANELS

- Aluminium Plate 1 - 2mm thick (From S2K)
- Clear Acrylic 1 - 2mm thick (From S2K)
- Coloured Acrylic 1 - 2mm thick (By Others)
- Alucobond 1 - 2mm thick (By Others)
- Stainless Steel 1 - 2mm thick (By Others)
- Or any other sheet material of above thickness
- Choose your preferred panel material
- If side access is limited we recommend you use flexible material for your Insert Panel

## FINISH

- Frame - the C Channel aluminium frame is Satin Natural Anodised
- End Caps - grey (flexible plastic)
- Painting - both the frame and the end caps can be painted if required

## MOUNTING & INSTALLATION

- Wall mounted
- Suspended – single or double-sided
- Flag mount – projecting mount
- Stainless steel braided wire for suspended signs
- Adjustable ceiling mounts
- Double-sided tape
- Silicone adhesive
- Counter sink concealed screw fixing

Method of attachment to the ceiling to be advised by the sign installer. Various connectors are available.

## SUITABLE USES

- Wayfinding
- Directional signs
- Public information
- Area identification
- Door signs
- Corporate or retail signage



01.....Wall mounted

02.....Flag / Projecting mount

03.....Double sided suspended

04.....Double sided suspended

05.....Detail image of Single sided suspended with acrylic insert panel

06.....Single sided suspended sign with acrylic insert panel and vinyl graphics





# Magnetic Sign Series

---

# Magnetic Sign Series:

**The Magnetic Sign Series is a slimline interchangeable sign system. It is suitable for a range of applications. The changeable Inserts are accessed from the front, simple to change and update. The front access makes this sign series a great choice for areas with limited access.**

Magnetic signs are available with both single and multiple Inserts. Graphics, text or digital prints can be applied directly to the face of the removable aluminium Inserts. The aluminium frame is designed to accept single or multiple aluminium Inserts that can be interchanged if required. The frame is available in a 2 sided and a 4 sided option.

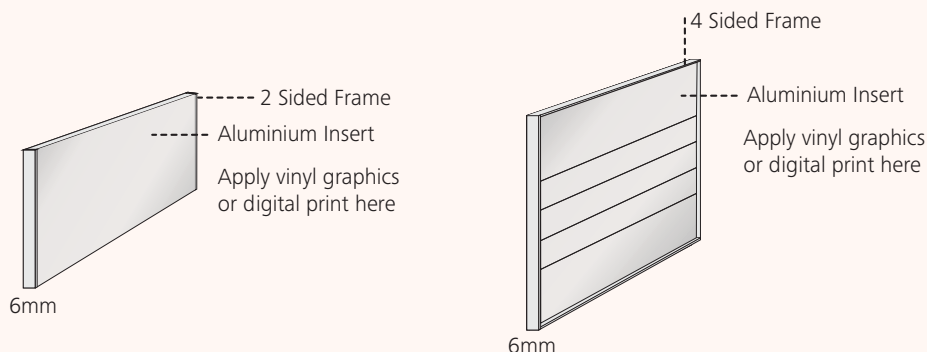
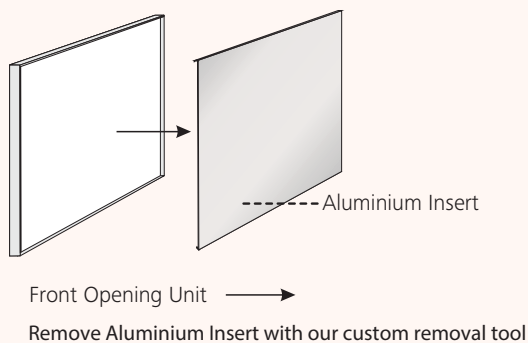

Magnetic Signs are offered with a 2 sided or a 4 sided frame. The option used will depend on the size and number of inserts on the sign. Contact S2K for more information.

## HOW TO OPERATE

Simply attach the custom removal tool to the Insert you wish to remove. Pull the Insert towards you using the tool, the Insert will release from within the frame. To replace, simply slip the Insert into position within the frame.

## SIZES

The Magnetic Sign Series is flexible in its design, thus offering many sizes and layouts.

Insert Height Options:

- 21mm, 42mm, 63mm, 84mm, 105mm, 126mm, 147mm, 168mm, 189mm, 210mm.....increasing in multiples of 21mm to a maximum single Insert height of 1197mm

Sign Width Options:

- 150mm, 200mm, 250mm, 300mm, 400mm, 450mm, 500mm, 550mm, 600mm, 650mm, 750mm, 800mm, 900mm, 1000mm, 1100mm, 1200mm

Custom Sizes are available on request.

01.



### FINISH

- Frame - Satin Natural Anodised Aluminium
- Inserts - Satin Natural Anodised Aluminium

### MOUNTING & INSTALLATION

- Wall mount
- Door mount
- Suspended
- Projecting / Flag
- Desk stand
- Double-sided tape
- Silicone adhesive
- Concealed counter sink screw fixing

### SUITABLE USES

- Door signs
- Personnel signs
- Directory boards
- Wayfinding
- Graphic information
- Room ID
- Department ID

02.



03.



04.



05.

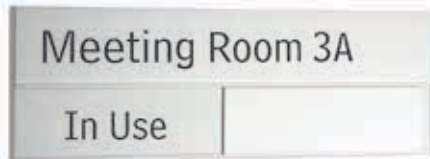

06.



07.



08.



09.



- 01.....Magnetic Sign Series Door Sign 150 x 126
- 02.....Magnetic Sign Series Door Sign 100 x 168
- 03.....Magnetic Sign Series Directory Board 500 x 630
- 04.....Magnetic Sign Series Door Sign 200 x 42
- 05.....Magnetic Sign Series Meeting Room Sign 200 x 84
- 06.....Magnetic Sign Series Directory Board 400 x 231
- 07.....Magnetic Sign Series Desk Sign 200 x 42
- 08.....Magnetic Sign Series Directory Board 250 x 294
- 09.....Magnetic Sign Series Black Anodised Directory with Brass Frame



# Workstation Sign Series

---

# Workstation Sign Series:

The Workstation Sign Series is designed for labelling workstations and other areas within the work environment. This sign series makes updating names, labels and graphics easy, cost effective, time efficient and streamlined. This system was designed with the end user in mind.

Workstation signs are available in a variety of sizes, formats and styles.

S2K custom manufacture aluminium workstation brackets to suit a wide variety of workstation screens and screen caps. As each screen system is different, so are the brackets.

The brackets are simple to mount over the top of a screen or alternatively they slot into the screen cavity.

The brackets enable the signs to be quickly and easily removed and replaced in another location quickly and conveniently.

Brackets can be attached to a wide variety of signs. Simply choose the sign system that best suits your needs, and then choose the desired bracket.

## C CHANNEL NAMEPLATES

The C Channel Name Plates are one option in the Workstation Sign Series. The C Channel is Satin Natural Anodised aluminium. There are 2 Insert options available for this system.

- **Clear cover** - Print your own graphics on paper and insert behind the cover or apply vinyl graphics to the reverse side of the clear cover
- **Aluminium plate** - Apply vinyl graphics directly to the face of the aluminium plate

## SIZES

C Channel Heights:

- 21mm, 42mm, 63mm, 84mm, 105mm, 126mm

C Channel Widths:

- 100mm, 150mm, 200mm, 250mm, 300mm

## FINISH

- Frame - Aluminium Satin Natural Anodised
- Cover - Clear
- Aluminium plate - Satin Natural Anodised

## MOUNTING & INSTALLATION

- Workstation mount
- Wall mount
- Door mount
- Desk stand
- Double-sided tape
- Silicone
- Magnetic tape

Clear Cover Option

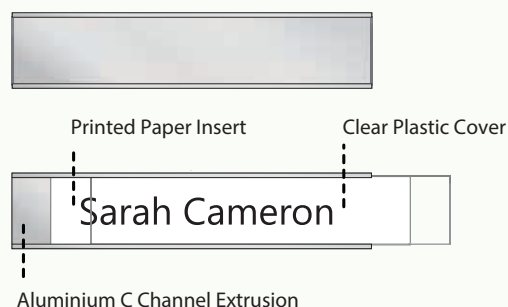

Aluminium Plate Option

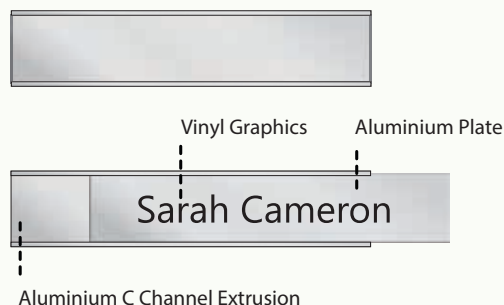

## WORKSTATION A4 & A3 INSERT SIGNS

The A4 & A3 Insert Signs form part of the Workstation Sign Series. These signs comprise of a 3 sided slimline aluminium frame and a clear cover.

There is open access at the top of the sign where printed paper can be inserted. The paper sits in between the aluminium frame and the clear cover.

Print your company logo, staff or location name to use the sign for staff ID as well as company branding.

The clear cover can also be used like a whiteboard. Simply write on the cover with a whiteboard marker. Remove with a whiteboard duster or smooth cloth.

## HOW TO OPERATE

Insert your printed paper in behind the clear cover. Only use a whiteboard marker to write on the clear cover. Use a clean cloth to remove the marker.

## SIZES

The Workstation A4 & A3 Insert Sign Series is available in the following standard sizes:

- A4 portrait
- A4 landscape
- A3 portrait
- A3 landscape

**Custom Sizes are available on request. Please nominate the size you require.**

## FINISH

- Frame - Satin Natural Anodised Aluminium
- Cover - clear plastic

## MOUNTING & INSTALLATION

- Workstation mount
- Wall mount
- Door mount
- Desk stand
- Double-sided tape
- Silicone adhesive

## SUITABLE USES

- Staff identification
- Messages
- Notes
- Meeting information
- Staff information



Workstation A4 Insert Sign with a clear cover and printed paper insert



C Channel Sign with clear cover and paper insert 200 x 42



## WORKSTATION BRACKETS

S2K manufacture brackets to suit each type and size of workstation.

Whether it's an S shaped bracket or a U shaped bracket, we can manufacture brackets to fit the chosen screen system.

### S Bracket

This Bracket can sit inside the groove within the screen system cap.

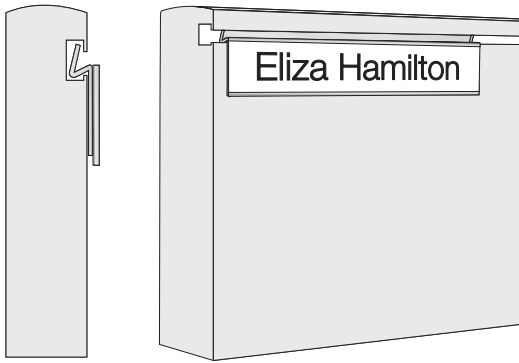

### U Bracket

This Bracket can sit over the top of the screen system cap.

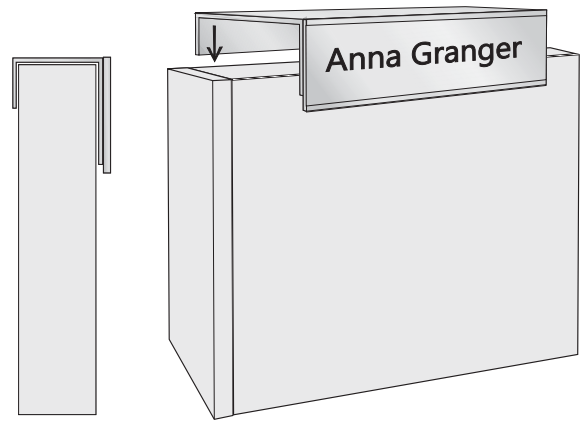

## WALL OR DOOR MOUNT

All of the signs in this brochure can be wall or door mounted if required. Simply order the sign without a bracket.



- 01.....A4 Workstation Sign with clear cover and paper insert
- 02.....Whiteboard on a workstation bracket for screen mount
- 03.....C Channel Workstation Sign with U Bracket and with paper insert 200 x 63
- 04.....C Channel Workstation Sign with U Bracket 100 x 126
- 05.....C Channel Workstation Sign with aluminium insert and vinyl graphics 250 x 42
- 06.....C Channel Workstation Sign with S Bracket 100 x 126
- 07.....C Channel Sign mounted to desk stand 250 x 42



03.



04.



05.



06.



07.





# Whiteboard Sign Series

---

# Whiteboard Sign Series:

---

**The Whiteboard Sign Series - a whiteboard with a slim aluminium frame. Fixed and removable whiteboards are available offering added flexibility.**

The frame can be 4-sided for a permanently fixed whiteboard or 3-sided to allow the whiteboard to be removed from the frame for added portability. These units are designed to be portable or fixed to a substrate.

01.



## SIZES

The Whiteboard Sign Series is available in the following standard sizes:

- A4 portrait
- A4 landscape
- A3 portrait
- A3 landscape

Custom Sizes are available on request. Please nominate the size you require.

**Custom sizes do not incur penalty charges.**

## COMBINE THE PAPER HANGER SERIES WITH THE WHITEBOARD SIGN SERIES

The Whiteboard with the 4-sided frame offers the option of adding a Paper Hanger at the top of the frame, this allows the addition of paper notes or messages if required.

## FINISH

- Frame - Satin Natural Anodised aluminium
- Whiteboard - Gloss White

## MOUNTING & INSTALLATION

- Wall mount
- Door mount
- Desk stand
- Workstation bracket – various
- Double sided tape
- Silicone adhesive

## SUITABLE USES

- Messages
- Notes
- Meeting information
- Patient information
- Staff information
- Workstation signage

3 Standard Options:

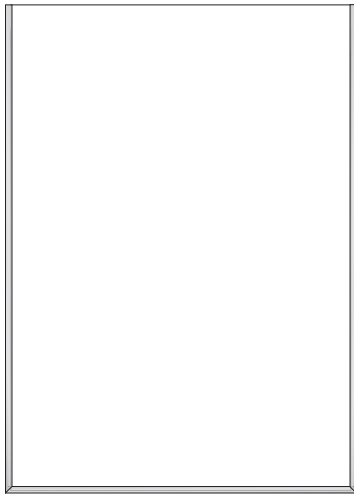

Whiteboard with 3-Sided Frame -  
Whiteboard is removeable



Whiteboard with 4-Sided Frame -  
Whiteboard is fixed

Aluminium Frame

PAPER HANGER SERIES

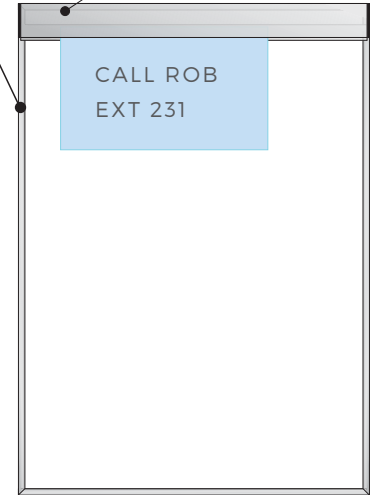

Whiteboard with 4-Sided Frame -  
with Paper Hanger attached

02.



04.



03.



05.



01..... Whiteboard on workstation bracket and removeable pen tray

02.....Whiteboard on workstation bracket for screen mount

03.....Whiteboard 450 x 350

04.....Whiteboard - A4P 4-Sided frame with Paper Hanger attached

05.....Whiteboard A3L





# Frame-X Sign Series:

**The Frame-X Series is a simple Alucobond graphic panel finished with a slim aluminium frame.**

The frame is 4-sided and is permanently fixed. These units are designed to be light, slimline, easy to install and attractive.



Frame-X 150 x 300



Frame-X 350 x 150

## SIZES

The Frame-X Series is available in the following standard sizes:

- 150mm x 150mm
- 300mm x 150mm
- 300mm x 300mm
- 500mm x 150mm
- 700mm x 150mm
- 100mm x 500mm
- 1000mm x 500mm
- 1000mm x 700mm
- 1500mm x 500mm
- 1500mm x 1000mm

**Custom Sizes are available on request. Please nominate the size you require.**

- Frame Width = 3.5mm
- Sign Depth = 6mm

## FINISH

- Frame - Satin Natural Anodised aluminium
- Alucobond colours – white, black, grey

**(other colours are available on request, conditions apply).**

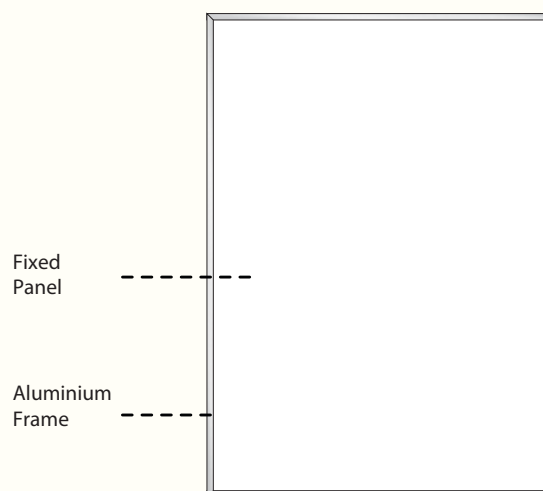



## MOUNTING & INSTALLATION

- Wall mount
- Door mount
- Desk stand
- Flag bracket – single or double-sided
- Workstation bracket – various
- Double-sided tape
- Silicone adhesive

## SUITABLE USES

- Room identification
- Staff identification
- Area identification
- Schedules
- Evacuation procedures
- Opening hours
- Hospital signage
- Name plates
- Instructions
- Menus
- Price lists
- Phone extensions / lists
- Staff notices

01.



01.....Frame-X 1000 x 700

02.....Frame-X Double Sided Flag Sign 300 x 300

03.....Frame-X 1000 x 700

04.....Frame-X Double Sided Flag Mount

05.....Frame-X 800 x 1200

03.



02.



04.



05.



# Absolute Product Quality:

---

S2K Identity Systems enjoys an enviable global reputation for the exceptional quality of its signage and display products. All of which are designed and developed to meet the highest specifications at a realistic cost.

Premium quality materials are used in the manufacture of each unit to ensure optimal performance over an extended period. Whilst quality is of paramount importance at S2K Identity Systems, we understand our customers need choices. For this reason, we offer an extensive range of product sizes,

materials, finishes and formats, each specifically tailored to meet the needs of the customer.

S2K Identity Systems is committed to the continual development and support of all of the signage, display systems and products in the S2K range.

# Contact:

---

S2K Identity Systems  
9 Lennox Street  
Moorabbin  
Victoria Australia 3189

**T:** 03 9555 7473

**E:** [info@s2k.com.au](mailto:info@s2k.com.au)

**W:** [www.s2k.com.au](http://www.s2k.com.au)

---

