

Workstation Signage Solutions

Signs for Workstations and Screen Systems

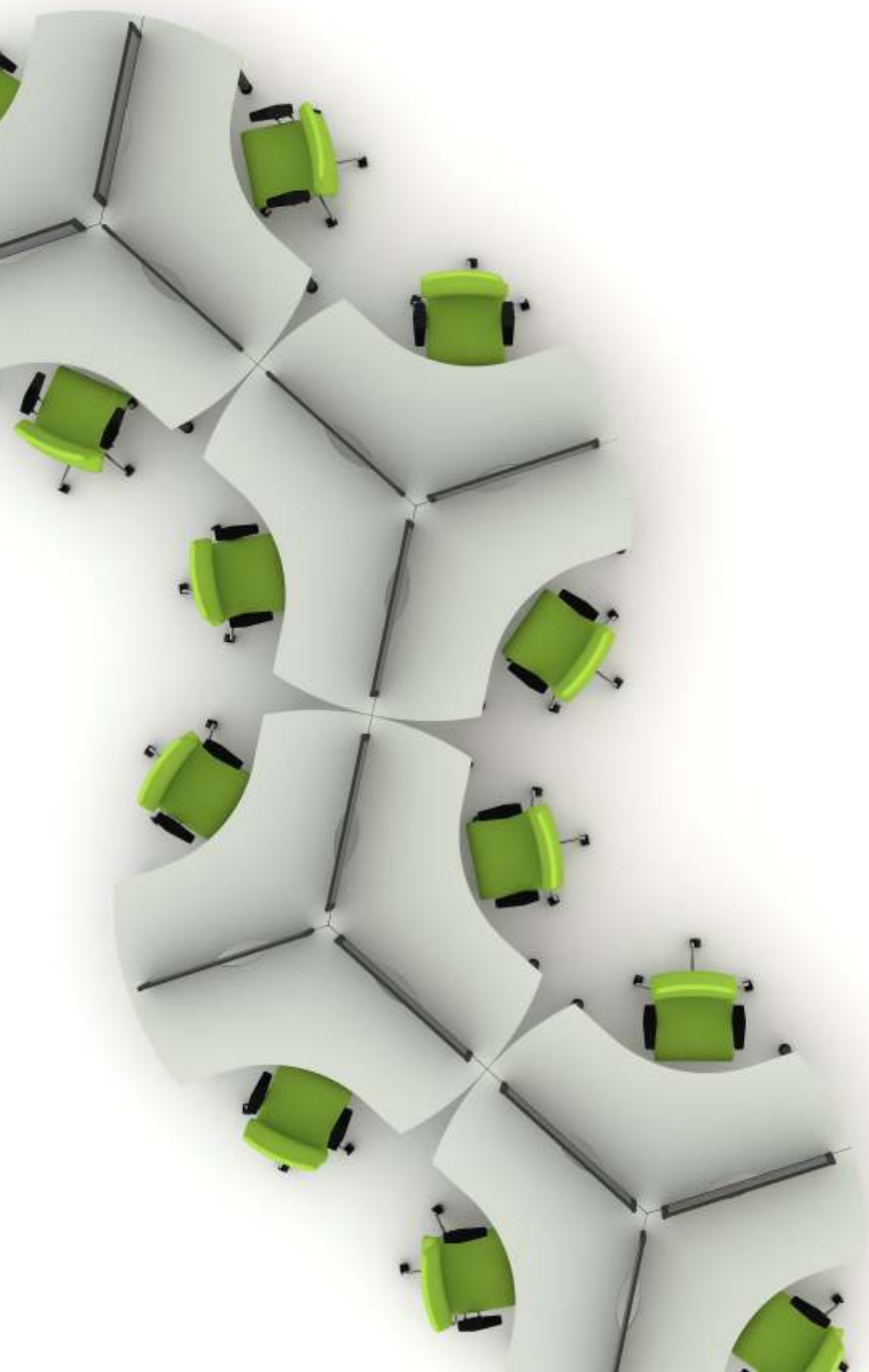

C CHANNEL NAMEPLATES

The C Channel Name Plates are part of the Workstation Sign Series. The C Channel is aluminium and has a clear anodised finish.

Optional Inserts for the Channel are:

- Clear Polycarbonate
- Aluminium Plate

Vinyl graphics can be applied directly to the face of the aluminium plate. Vinyl graphics can also be applied to the reverse side of the clear polycarbonate insert.

Alternatively, print your graphics on paper, trim and insert the paper in behind the clear polycarbonate cover.

Clear Cover Option

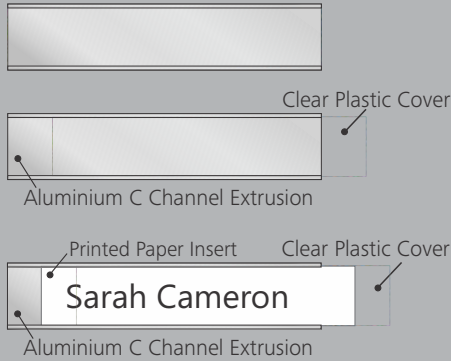

FINISH

- Frame - The standard finish is clear anodised aluminium - SNA
- Cover - clear polycarbonate
- Aluminium Plate - SNA

INSTALLATION

- Workstation Mount - The Nameplate sign is attached directly to a custom bracket which either slips into the cavity in the workstation screen cap, or over the top of the workstation screen.

Magnetic Tape is also available.

Aluminium Plate Option

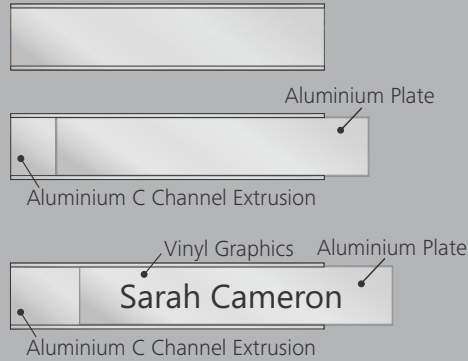

SIZES

The C Channel Nameplate Signs are available in the following standard sizes:

- 21mm High - Various Widths
- 42mm High - Various Widths
- 63mm High - Various Widths

See Page 4 for a full listing of sizes offered.

WORKSTATION BRACKETS

- S Bracket - Refer to Page 4
- U Bracket - Refer to Page 4

HOW TO OPERATE

Clear Cover Option:

- Slide your printed paper under the clear cover.
- Apply vinyl graphics to the back of the clear cover.

Aluminium Plate Option:

- Apply vinyl graphics directly to the face of the aluminium plate.

WALL OR DOOR MOUNT

All of the signs in this brochure can be wall or door mounted if required. Simply order the sign without a bracket.



Pin Mount - Suitable for fabric screens

All sign types included in this brochure can be wall mounted as an alternative option. Please nominate wall mount installation if you do not require a workstation bracket.

WORKSTATION A4 & A3 INSERT SIGNS

The A4 & A3 Workstation Sign Series is a 3 sided slimline aluminium frame, with a clear plastic cover.

There is open access at the top of the sign where you can insert a piece of printed paper. The paper sits behind the clear cover.

Print your company logo, staff or location name and use the sign for staff ID as well as company branding.

The clear cover also acts as a whiteboard. Simply write on the cover with a whiteboard marker. Remove the marker with a whiteboard eraser or smooth cloth.

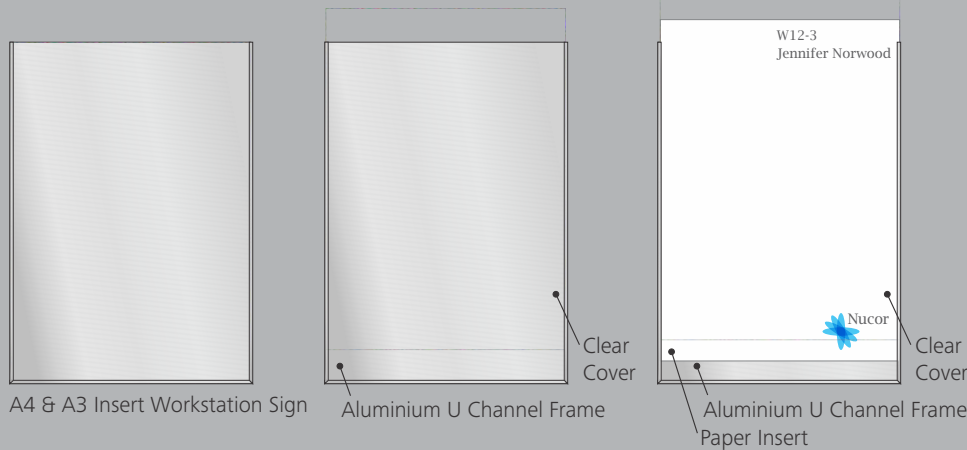

FINISH

- Frame - The standard finish is clear anodised aluminium.
- Cover - clear polycarbonate

INSTALLATION

- Workstation Mount - This sign can be attached to a custom bracket and fixed directly to a workstation screen.
- Wall Mount - These signs can be attached to a flat surface or substrate with double-sided tape and silicone if needed.

Please specify the mounting option you require.

SIZES

The Workstation A4 & A3 Insert Sign Series is available in the following standard sizes:

- A4 Portrait
- A4 Landscape
- A3 Portrait
- A3 Landscape

Custom sizes are available on request. Please nominate the size you require.

POSSIBLE USES

- Messages
- Notes
- Meeting Information
- Patient Information
- Staff Information
- Workstation Signage

HOW TO OPERATE

Only use a whiteboard marker to write on the whiteboard signs.

Use a clean cloth or whiteboard eraser to remove marker.

WALL OR DOOR MOUNT

All of the signs in this brochure can be wall or door mounted if required. Simply order the sign without a bracket.



All sign types included in this brochure can be wall mounted as an alternative option. Please nominate wall mount installation if you do not require a workstation bracket.

WORKSTATION SIGN SERIES

The Workstation Sign Series is designed to make updating names, labels and graphics easy, cost effective, time efficient and streamlined. This system was designed with the end user in mind.

The 2 options include:

- Insert the printed or paper graphics in behind the clear cover,
- Add your vinyl graphics directly to the aluminium plate.

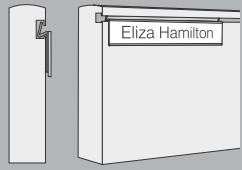

S Bracket

This Bracket can sit inside the groove within the screen system cap.

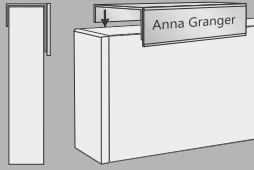

U Bracket

This Bracket can sit over the top of the screen system cap.

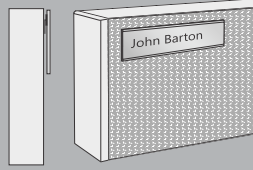

Pin Mount

Two custom pins attached to the back of the sign allow mounting to the fabric

NOTE: There are variations of each of these bracket options. The final sizes, shapes and dimensions will be determined by which screen system is used.

C CHANNEL NAMEPLATES

SIZES

21mm High Channel is available in the following width sizes.
100mm Wide, 150mm Wide, 200mm Wide, 250mm Wide, 300mm Wide

42mm High Channel is available in the following width sizes.
100mm Wide, 150mm Wide, 200mm Wide, 250mm Wide, 300mm Wide

63mm High Channel is available in the following width sizes.
100mm Wide, 150mm Wide, 200mm Wide, 250mm Wide, 300mm Wide

Other sizes include: 84mm High, 105mm High 126mm High
These are also offered in the standard widths of: 100mm 150mm 200mm 250mm 300mm

1. Choose the sign size you require
2. Choose the bracket style, S or U or Pin Mount

Other sizes available on request.

BRACKET DETAILS

S2K manufacture brackets to suit each type and size of workstation.

Whether its an S shaped bracket or a U shaped bracket, we can manufacture brackets to fit the chosen screen system.

Details and dimensions may be required.

Please include this information for S2K with your quote request or order.

All signs are supplied with a bracket attached unless otherwise specified.

OPTIONS FOR INSERTS

Option 1



Requires printed paper graphics by others.

Option 2

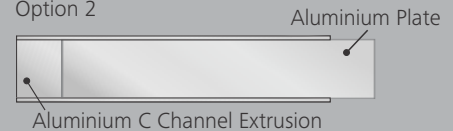

Requires vinyl adhesive graphics by others.

WORKSTATION A4 & A3 INSERT SIGNS

SIZES

Size A4P - 212 W x 298 H

Size A4L - 299 W x 211 H

Size A3P - 299 W x 421 H

Size A3L - 422 W x 298 H

1. Choose the size you require
2. Choose the bracket style, S or U or Pin Mount

Other sizes available on request.

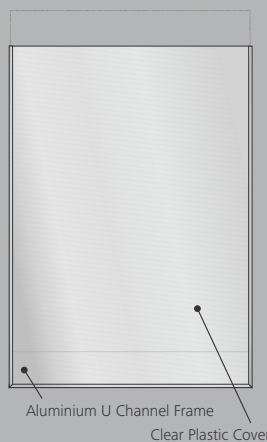

WALL MOUNT INSTALLATION

All sign types included in this brochure can be wall mounted as an alternative installation method.

Wall mounted signs are supplied without the workstation bracket.

Please nominate wall mount installation if you do not require a workstation bracket.

Double sided tape can be supplied on request.

CONTACT DETAILS

S2K Identity Systems
9 Lennox Street, Moorabbin, Victoria, Australia 3189

T: 613 9555 7473 F: 613 9555 7579
E: info@s2k.com.au W: www.s2k.com.au